

GRU A TORRE

GA 727D80 | 2500

GRU AUTOMATICA CON
MONTAGGIO IDRAULICO

GA compact



GX



GH city crane



GHS topless



FB F.lli Butti s.r.l.

Via XXV Aprile, 58

23868 Valmadrera (LC) - Italia

Tel. 0341.581108 - Fax 0341.200253

E-mail : fbgru@fbgru.it - <http://www.fbgru.it>



FEM 1.001 - A3
EN 14439 - C25

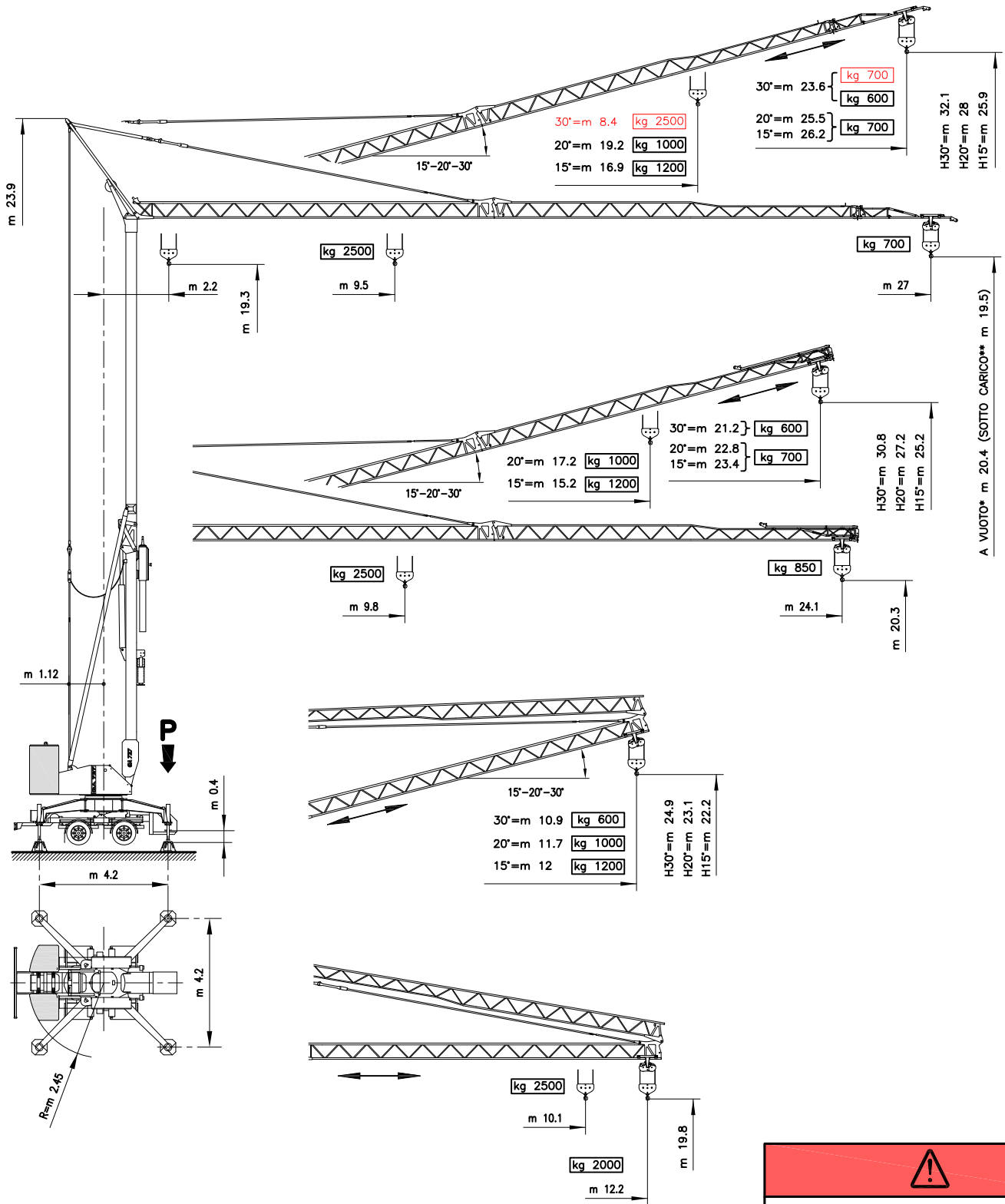



* SIN CARGA ** CARGADO
 OFF-LOAD LOADED
 UNBELASTET BELASTET
 A VIDE EN CHARGE

!

In rosso valori configurazione con dispositivo per 30°
 In red, configuration values with device for 30°
 In Rot, Konfigurationswerte mit Einrichtung für 30°
 En rouge le valeurs de configuration avec dispositif pour 30°

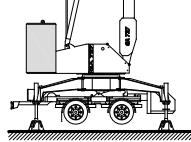
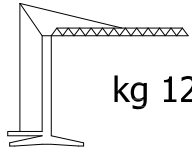
P	
kg 14890	kg 16310
<i>In servizio</i>	<i>Fuori servizio</i>
En servicio In service In betrieb En service	Fuera de servicio Out of service Außer betrieb Hors service

!	
 N° 2x4100 kg 21000	 kg 12800

MOVIMENTO MOVIMIENTO MOVEMENT BEWEGUNG MOUVEMENT	ALIMENTAZIONE ALIMENTACION OPERATING VOLTAGE BETRIEBSSPANNUNG TENSION DE SERVICE	PRESTAZIONI FUNCIONAMIENTOS PERFORMANCES LEISTUNGEN EXÉCUTIONS	
---	---	---	---

		1 ^a m/1' - kg		2 ^a m/1' - kg		3 ^a m/1' - kg		4 ^a m/1' - kg		kW 9.2				
SOLLEVAMENTO ELEVACION – HOISTING HEBEN – LEVAGE  INVERTER	230 V 50 Hz	3 kW	3.2 ↑	6 ↓	8 ↑	11 ↓	19 ↑	20 ↓	2500		2500	700		
			3.2 ↑	6 ↓	8 ↑	11 ↓	30 ↑	32 ↓					700	
	400 V 50 Hz	6 kW	3.2 ↑	6 ↓	21 ↑	25 ↓	39 ↑	42 ↓	46 ↑		50 ↓	2500	2500	700
			3.2 ↑	6 ↓	21 ↑	25 ↓	39 ↑	42 ↓	46 ↑	50 ↓	600			

		1 ^a m/1'	2 ^a m/1'	3 ^a m/1'	kW 2.2
CARRELLO CARRILLO – JIB TROLLEY LAUFKATZE – DISTRIBUTION  INVERTER	230 - 400 V 50 Hz	15	23	41	

		1 ^a g/1'	2 ^a g/1'	3 ^a g/1'	kW 2.2
ROTAZIONE ROTACION – SLEWING DREHEN – ORIENTATION  INVERTER	230 - 400 V 50 Hz	0 → 0.19	0.19 → 0.47	0.47 → 0.87	



Conforme alle direttive
CEE sul livello acustico
2000/14/CE

Conforme con las directivas
CEE sobre el nivel acustico

In compliance with the EEC
instructions on noise level





Gemäss EWG-Richtlinien für
den Schall-Leistungspegel

Conforme aux directives CEE
sur le niveau acoustique

CURVE DI CARICO

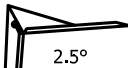
CURVAS DE CARGAS – LOAD DIAGRAMS LASTKURVEN – COURBES DE CHARGES

V27 

 2.5°	m	2.2	5	9.5	11	13	15	17	19	21	23	24.1	25	27
	kg	2500			2085	1707	1438	1237	1082	957	856	808	771	700
 15°	m	2.2	5	8	11	13	15	16.9	19	21	23	24	25	26.2
	kg	1200							1043	923	825	778	743	700
 20°	m	2.2	5	8	11	13	15	17	19.2	21	23	24	25	25.5
	kg	1000								893	797	756	718	700
 30°	m	2.2	5	7	9	11	13	15	17	19	20	21	22	23.6
	kg	600												
 30°	m	2.2	5	7	8.4	11	13	15	17	19	20	21	22	23.6
	kg	2500				1790	1462	1229	1055	919	863	811	765	700

POTENZA RICHIESTA

POTENCIA-ELECTRICA NECESARIA – NECESSARY ELECTRIC POWER KRAFTBEDARF – PUISSANCE ELECTRIQUE NECESSAIRE

	3 kW 230 V - 50 Hz	6 kW 230 V - 50 Hz	12 kW 400 V - 50 Hz
---	-----------------------	-----------------------	------------------------

GA 727D80 - 2500

Con riserva di modifiche
documento commerciale
non vincolante

Derecho de modificaciones reservadas
documento comercial no contractual

Subject to change without notice
commercial document not legally
binding

Anderungen vorbehalten
Unverbindliches
Vertriebsdokument

Modifications réservées
document commercial
non contractuel

TRASPORTO TRANPORTE – TRANSPORT
TRANSPORT – TRANSPORT

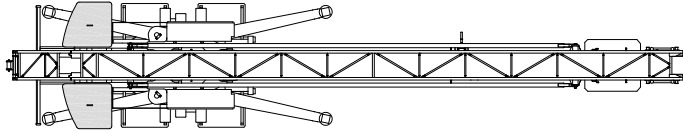
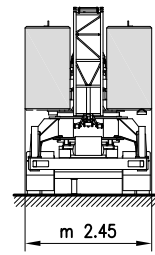
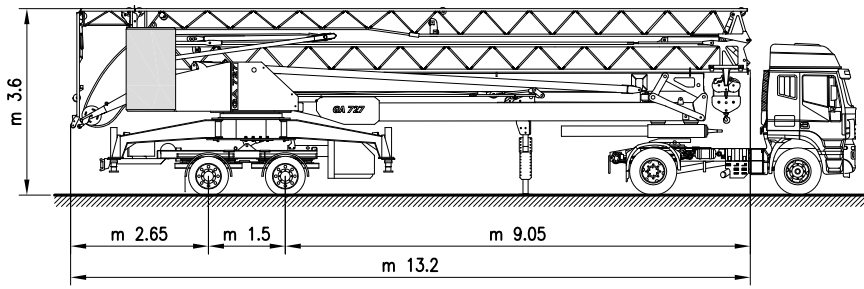

MONTAGGIO MONTAJE – ERECTION
MONTAGE – MONTAGE

